



Vertigo **Finiture cromatiche** Colour finishing

Piani di lavoro in laminato sp. 18 mm con bordi in ABS sp. 2 mm.
 Laminate working tops 18 mm thick with ABS edge-profiles 2 mm thick.
 Plateaux en laminé ép. 18 mm avec chants en ABS ép. 2 mm.
 Tischplatten aus Laminat St. 18 mm mit ABS-Kanten St. 2 mm.
 Sobres de trabajo en laminado 18 mm de grosor con cantos en ABS 2 mm de grosor.
 Plano de trabalho em laminado de espessura de 18 mm e com bordos em ABS de espessura de 2 mm.



Bianco lucido
 Polished white
 Blanc luisant
 Weiß Hochglanz
 Blanco brillo
 Branco brilhante



Rosso lucido
 Polished red
 Rouge luisant
 Rot Hochglanz
 Rojo brillo
 Vermelho brilhante

Piani di lavoro in vetro temperato sp. 10 mm.
 Working tops in tempered glass 10 mm thick.
 Plans de travail en verre trempé ép. 10 mm.
 Tischplatten aus Sicherheitsglas St. 10 mm.
 Sobre de trabajo en cristal templado 10 mm de grosor.
 Plano de trabalho em vidro temperado espessura de 10 mm.



Bianco - White
 Blanc - Weiß
 Branco - Branco



Nero - Black
 Noir - Schwarz
 Negro - Preto

Piani di lavoro in melaminico sp. 18 mm con bordi in ABS sp. 2 mm.
 Melamine working tops 18 mm thick with ABS edge-profiles 2 mm thick.
 Plateaux en mélaminé ép. 18 mm avec chants en ABS ép. 2 mm.
 Tischplatten in Melamin St. 18 mm mit ABS-Kanten St. 2 mm.
 Sobres de trabajo en melamina 18 mm de grosor con cantos en ABS 2 mm de grosor.
 Plano de trabalho em melaminico espessura 18 mm com bordos em ABS espessura 2 mm.

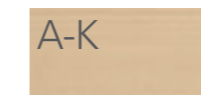

Acero - Maple
 Erable - Ahorn
 Arce - Bordó



Noce - Walnut
 Noyer - Nussbaum
 Nogal - Nogueira

Strutture in alluminio verniciato con giunti cromati.
 Painted aluminium metal structures with chromed connection joints.
 Structures en aluminium verni avec joints chromés.
 Strukturen aus lackiertem Aluminium mit verchromten Verbindungselementen.
 Estructuras en aluminio barnizado con piezas de unión cromadas.
 Estruturas em alumínio pintadas com juntas cromadas.



Alluminio
 Aluminium
 Aluminium
 Aluminium
 Aluminio
 Alumínio

Vertigo

Maniglia di serie per ante e cassetti.
 Standard handle for doors and drawers.
 Poignée standard pour portes et tiroirs.
 Standardgriff für Türen und Schubladen.
 Tirador de serie para puertas y cajones.
 Puxador de série para portas e gavetas.

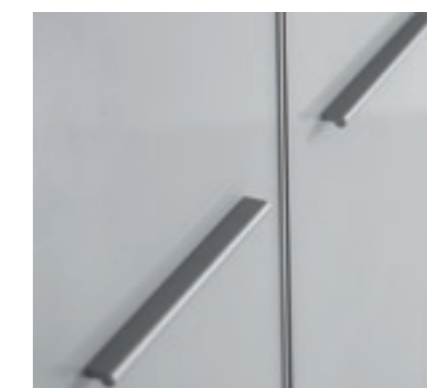

VERTIGO

TAVOLI SCRIVANIA - DESKS

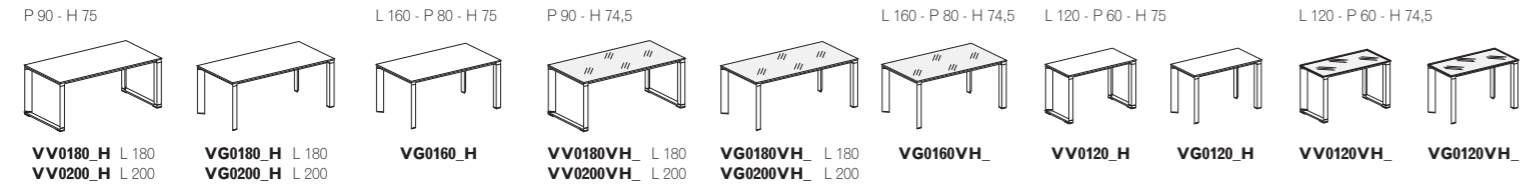

TAVOLI COMPOSTI - COMPOUND DESKS

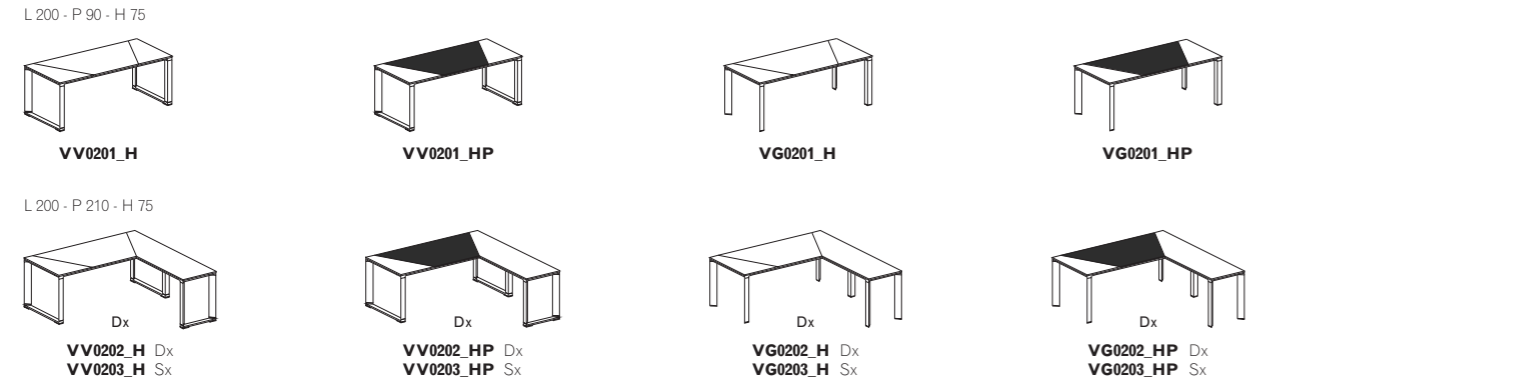

CASSETTIERE / ELEMENTI DI SERVIZIO - PEDESTALS / SERVICE UNITS

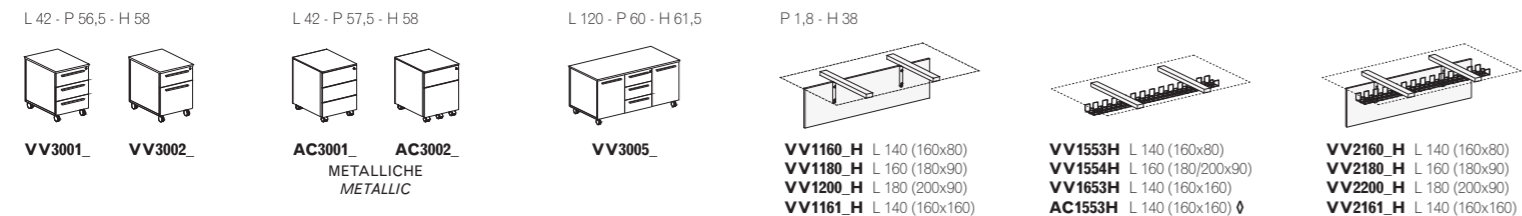

MODESTY PANEL / CANALIZZAZIONE - MODESTY PANEL / WIRING MANAGEMENT

TAVOLI RIUNIONE - MEETING TABLES

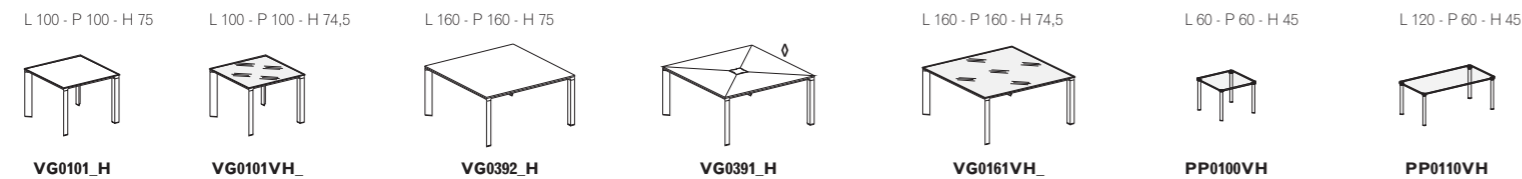

TAVOLI CAFFÈ - COFFEE TABLES

TAVOLI RIUNIONE COMPONIBILI - COMPOUND MEETING TABLES

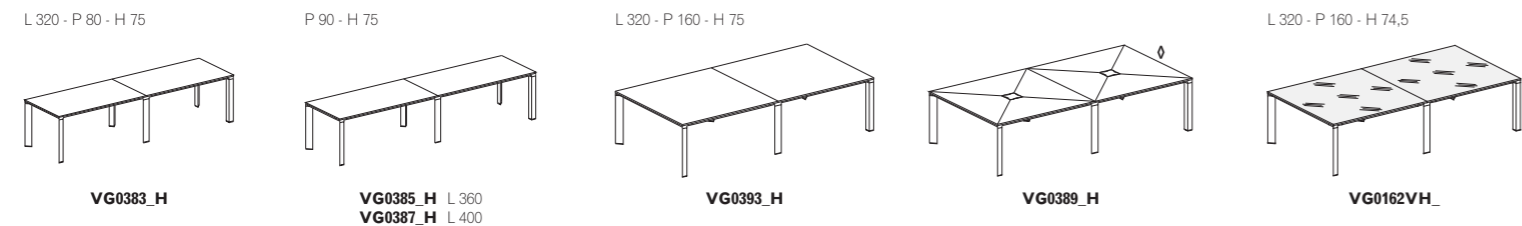

ELEMENTI PER TAVOLI RIUNIONE COMPONIBILI - MODULAR ELEMENTS FOR COMPOUND MEETING TABLES

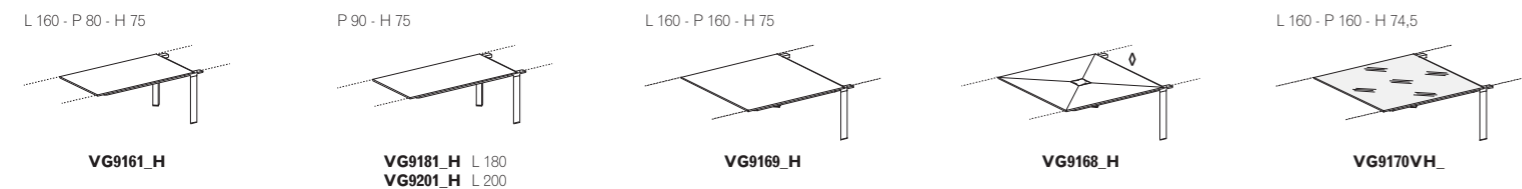

N.B.: LE DIMENSIONI SONO ESPRESSE IN CM. CONSULTARE IL LISTINO PREZZI PER LE CARATTERISTICHE TECNICHE, I CODICI DEGLI ARTICOLI E DELLE FINITURE.
 N.B.: THE DIMENSIONS ARE STATED IN CM. FOR TECHNICAL CHARACTERISTICS, ARTICLE CODE NUMBERS AND FINISHING, SEE PRICE LIST.

VERTIGO

CONTENITORI ANTE SCORREVOLI COMPLANARI - STORAGE UNITS WITH COPLANAR SLIDING DOORS

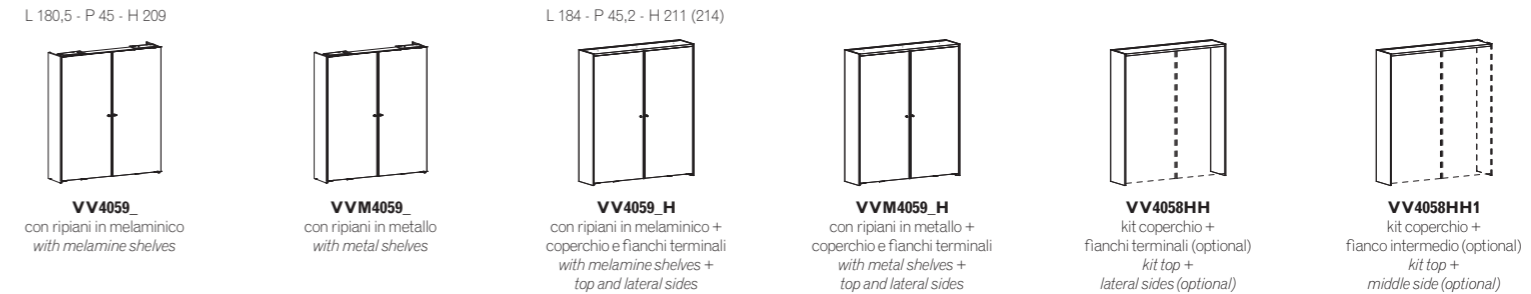

BOISERIE - BOISERIE

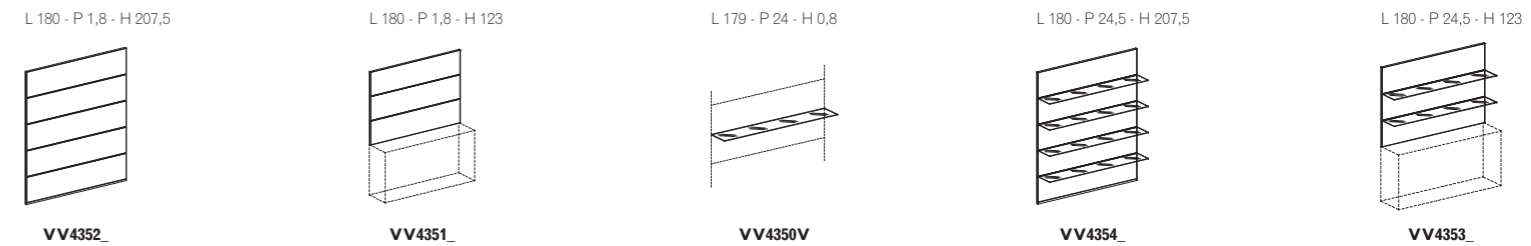

COMPOSIZIONI BOISERIE - BOISERIE COMPOSITIONS

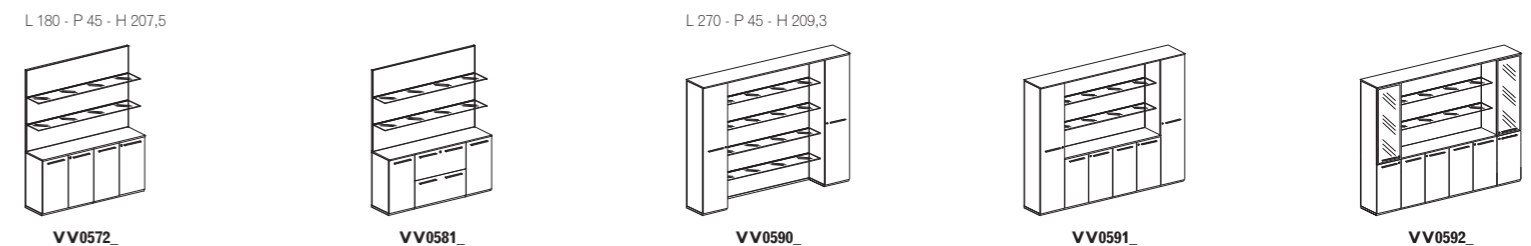

LIBRERIE - BOOKCASES

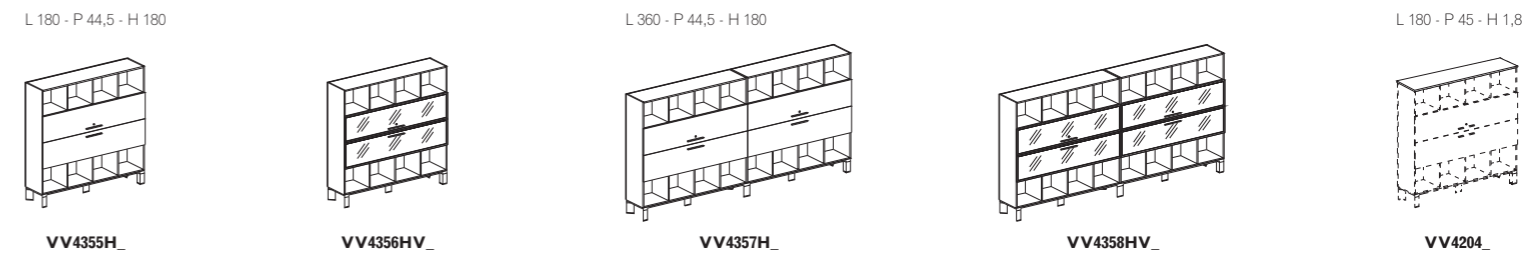

N.B.: LE DIMENSIONI SONO ESPRESSE IN CM. CONSULTARE IL LISTINO PREZZI PER LE CARATTERISTICHE TECNICHE, I CODICI DEGLI ARTICOLI E DELLE FINITURE.
 N.B.: THE DIMENSIONS ARE STATED IN CM. FOR TECHNICAL CHARACTERISTICS, ARTICLE CODE NUMBERS AND FINISHING, SEE PRICE LIST.

VERTIGO

ACCESSORI - ACCESSORIES

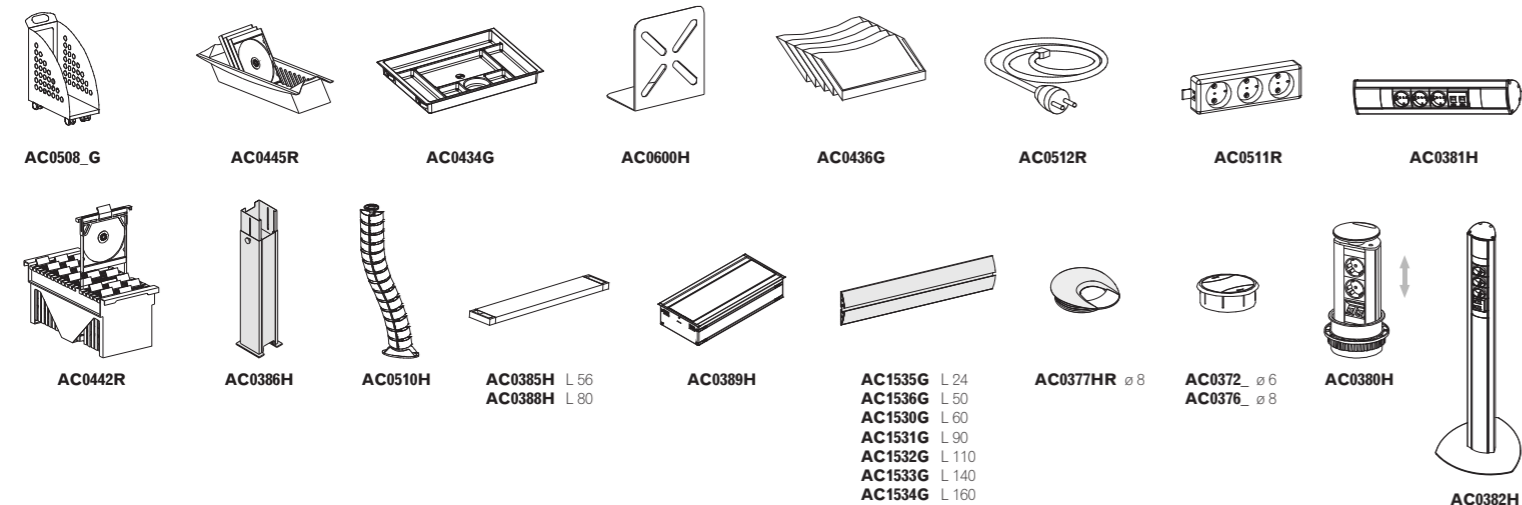

CONTENITORI - STORAGE UNITS

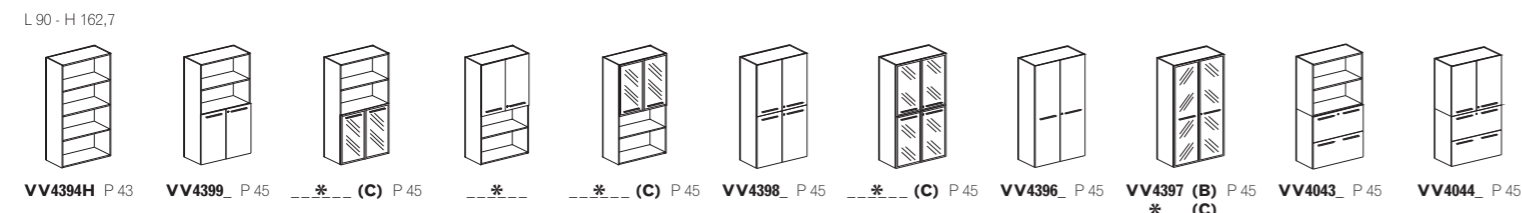
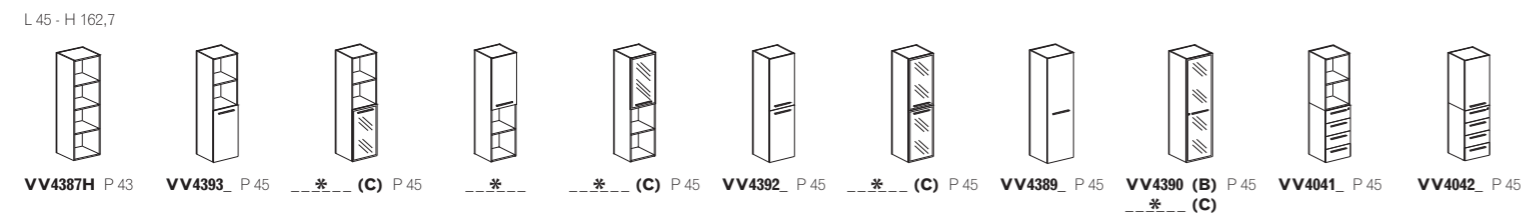
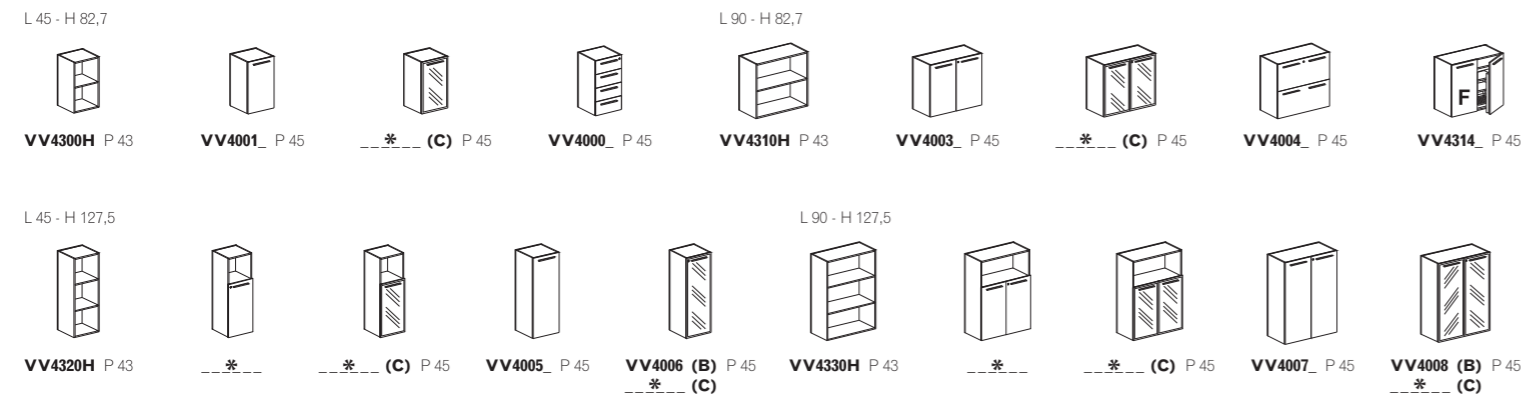

VERTIGO

CONTENITORI - STORAGE UNITS

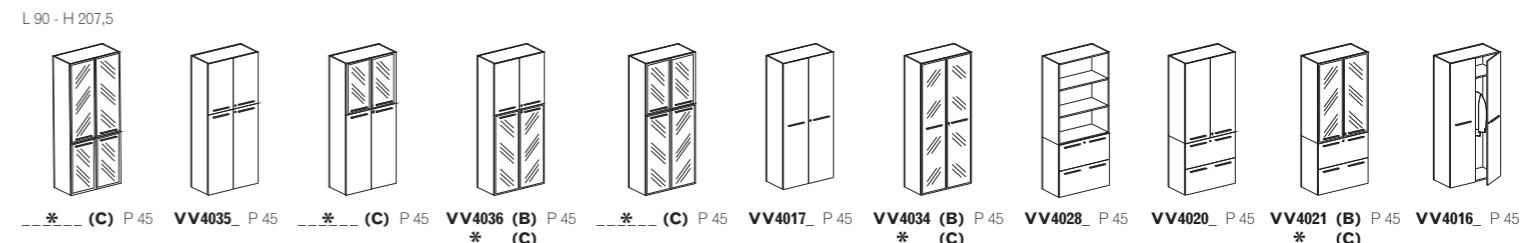
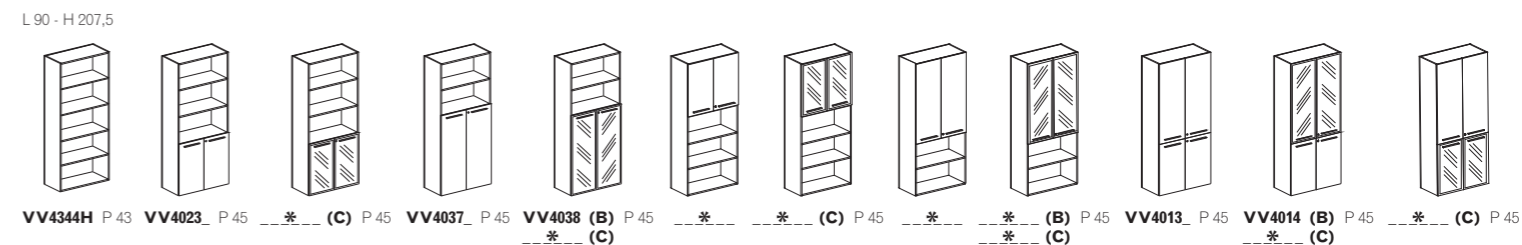
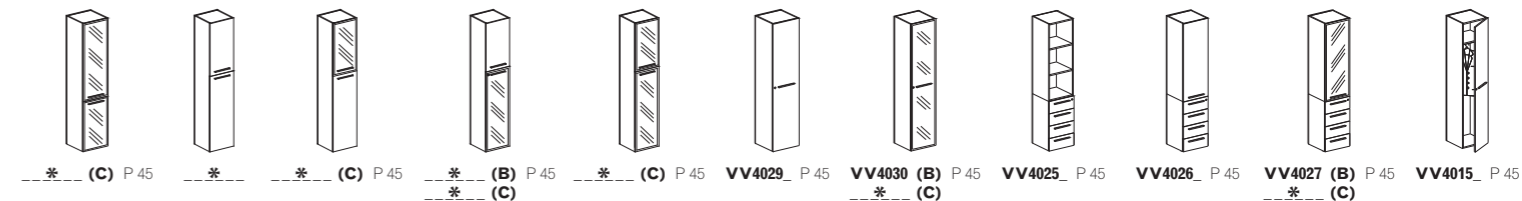
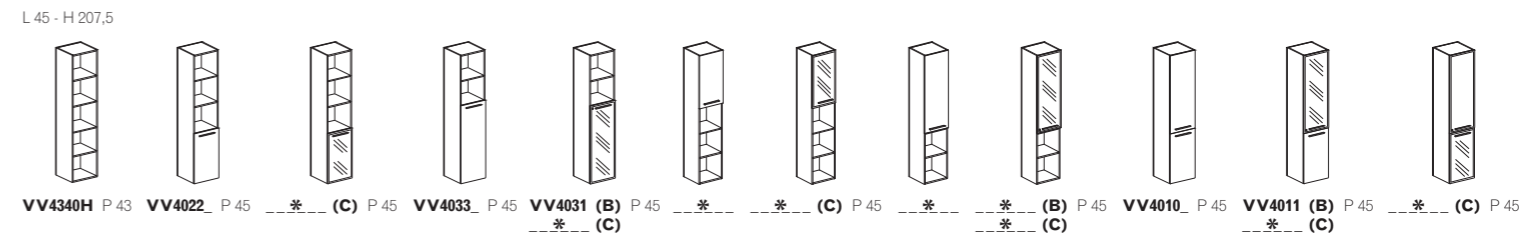

TOP - TOPS

P 45 - H 1,8



VV4201 L 45
VV4202 L 90
VV4203 L 135
VV4204 L 180
VV4205 L 225
VV4206 L 270

ZOCCOLI METALLICI (OPTIONAL) - BASE METAL FRAMES (OPTIONAL)

P 41,5 - H 2,8

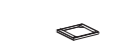

AC4445H L 45
AC4490H L 90

CONTENITORI SU RUOTE - STORAGE UNITS ON CASTORS

L 90 - P 45 - H 93,8



VV4050

L 90 - P 45 - H 138,6

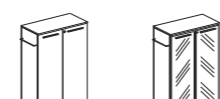

VV4055 **VV4057 (B)** *** (C)**

TIPOLOGIE ANTE VETRO DISPONIBILI - GLASS DOORS AVAILABLE

B: Anta vetro acidato con telaio in alluminio dotata di serratura (standard) **C:** Anta vetro retrolaccata con telaio in alluminio (optional)
 Acetated glass door with aluminium frame and lock (standard) Rear-lacquered glass door with aluminium frame (optional)

* Per il codice consultare il listino prezzi | For the code, see price list.

I CONTENITORI FISSI SONO COMPONIBILI, SOVRAPPONIBILI E VANNO COMPLETATI CON I TOP SP. 1,8 CM. I CODICI RIPORTATI SI RIFERISCONO A CONTENITORI CON RIPIANI IN MELAMINICO.
THE FREE-STANDING STORAGE UNITS ARE MODULAR, SUPERIMPOSABLE AND HAVE TO BE COMPLETED WITH TOPS 1,8 CM THICK. THE CODES ARE RELATED TO STORAGE UNITS WITH MELAMINE SHELVES.